

SMT to SOIC-Wide Header (1.27mm Pitch, for 300 mil IC body)

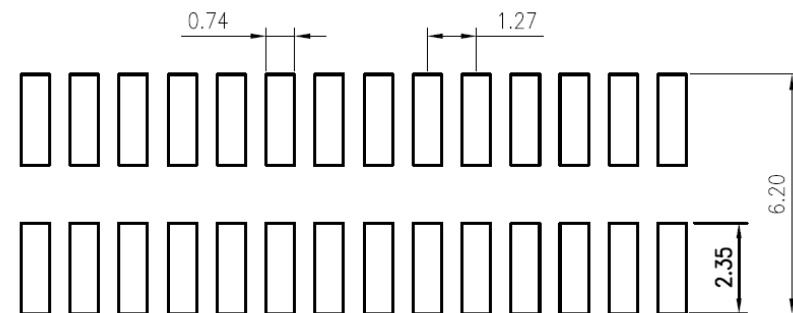

P.C.B. LAYOUT

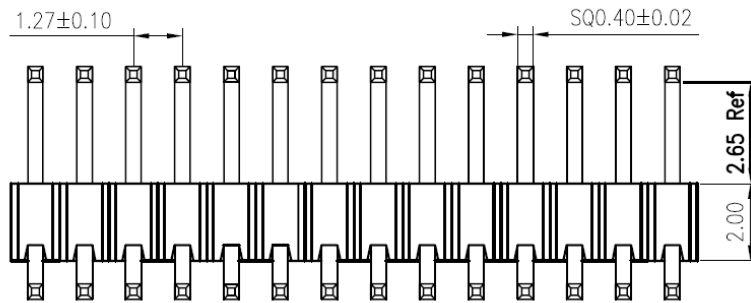
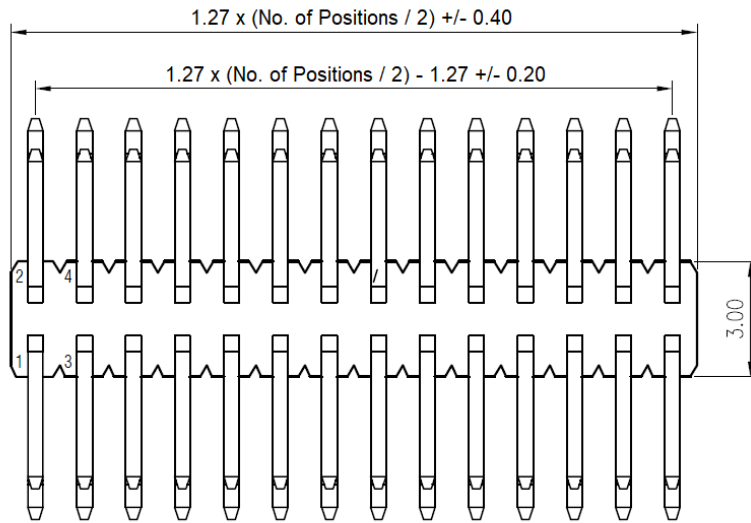
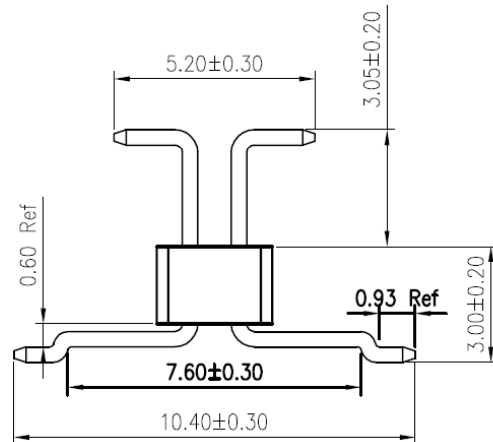

SPECIFICATIONS

Plastic body construction:	PA6T plastic (320°C melting point)
Pin construction:	Gold plated (brass pin, with 1um gold over 50um nickel)
Operating temperature range:	-40°C to +130°C
Reflow maximum temperature:	+260°C
Current rating:	1.0 Amp / contact
Contact resistance:	≤ 20 mΩ / contact
Insulation resistance:	≥ 500 MΩ (at V = 100V)
Withstanding voltage:	300 V AC / minute

AVAILABLE PART NUMBERS

Orderable Part Number	Total Pin Count	Pin Arrangement
HDR-SOICW-08	8	2x4
HDR-SOICW-10	10	2x5
HDR-SOICW-12	12	2x6
HDR-SOICW-14	14	2x7
HDR-SOICW-16	16	2x8
HDR-SOICW-18	18	2x9
HDR-SOICW-20	20	2x10
HDR-SOICW-22	22	2x11
HDR-SOICW-24	24	2x12
HDR-SOICW-26	26	2x13
HDR-SOICW-28	28	2x14
HDR-SOICW-80	80	2x40

PART PHOTOS



HDR-SOICW-08

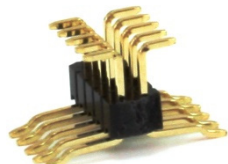

HDR-SOICW-10

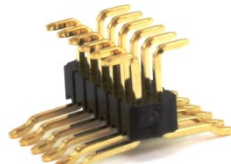

HDR-SOICW-12

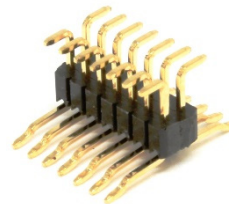

HDR-SOICW-14

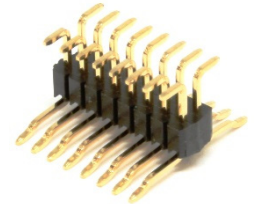

HDR-SOICW-16

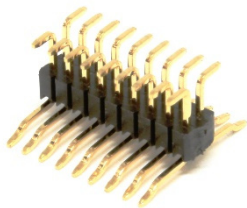

HDR-SOICW-18

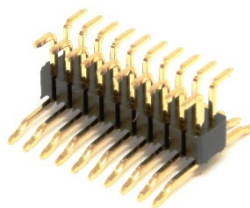

HDR-SOICW-20

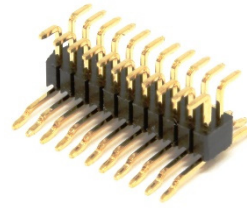

HDR-SOICW-22

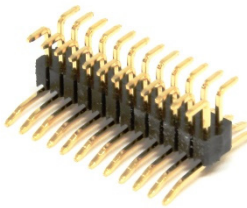

HDR-SOICW-24

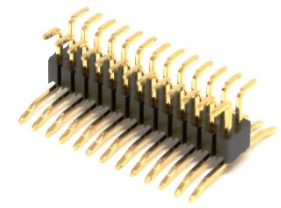

HDR-SOICW-26

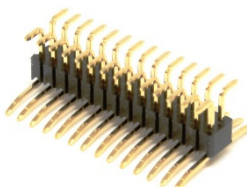

HDR-SOICW-28

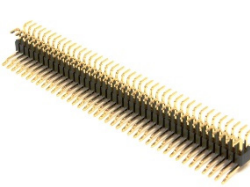

HDR-SOICW-80