

Pitch Changer 1.27mm to 2.54mm conversion - 10 Pin

REF.	DIMENSIONS						Pin Count
	mm			inches			
	MIN.	TYP.	MAX.	MIN.	TYP.	MAX.	
E1		1.27					
E2		2.54					
H1		0.64					
H2		1.00					
n							10

Top View (TH Footprints)

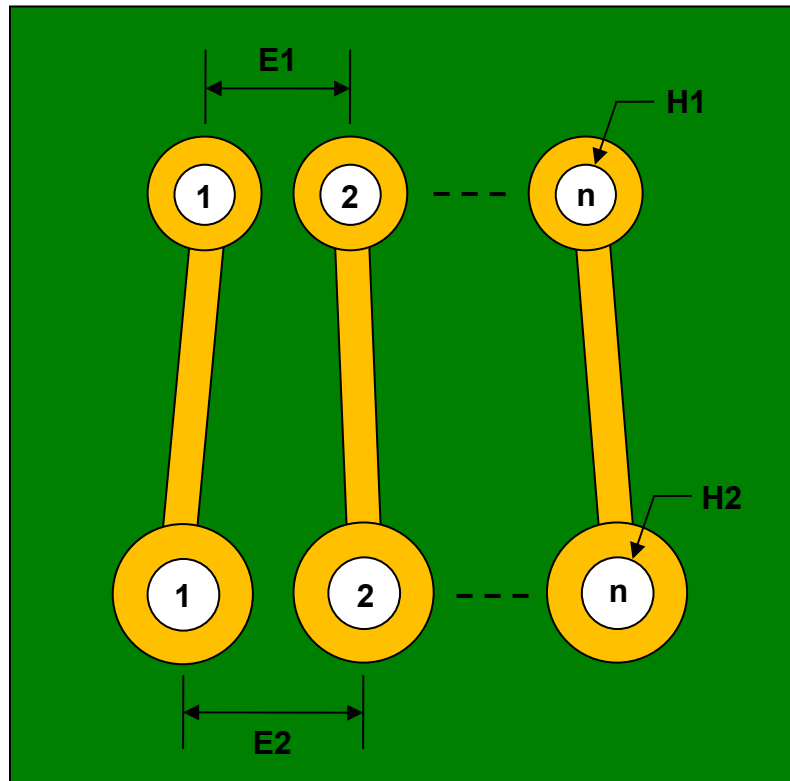

(Representative drawing only - not to scale)

Part Number Coding

From Pitch (mm): 1.00, 1.27, 2.00, 2.54

To Pitch (mm): 1.00, 1.27, 2.00, 2.54

Pin Count: 4, 5, 6, 8, 10, 16, 20

Rule: From Pitch ≤ To Pitch

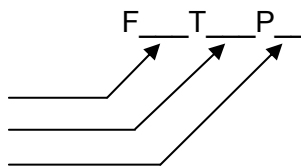

Orderable Part Numbers

Part Number	From Pitch	To Pitch	Pin Count
F100T100P04	1.00mm	1.00mm	4
F100T100P05	1.00mm	1.00mm	5
F100T100P06	1.00mm	1.00mm	6
F100T100P08	1.00mm	1.00mm	8
F100T100P10	1.00mm	1.00mm	10
F100T100P16	1.00mm	1.00mm	16
F100T100P20	1.00mm	1.00mm	20
F100T127P04	1.00mm	1.27mm	4
F100T127P05	1.00mm	1.27mm	5
F100T127P06	1.00mm	1.27mm	6
F100T127P08	1.00mm	1.27mm	8
F100T127P10	1.00mm	1.27mm	10
F100T127P16	1.00mm	1.27mm	16
F100T127P20	1.00mm	1.27mm	20
F100T200P04	1.00mm	2.00mm	4
F100T200P05	1.00mm	2.00mm	5
F100T200P06	1.00mm	2.00mm	6
F100T200P08	1.00mm	2.00mm	8
F100T200P10	1.00mm	2.00mm	10
F100T200P16	1.00mm	2.00mm	16
F100T200P20	1.00mm	2.00mm	20
F100T254P04	1.00mm	2.54mm	4
F100T254P05	1.00mm	2.54mm	5
F100T254P06	1.00mm	2.54mm	6
F100T254P08	1.00mm	2.54mm	8
F100T254P10	1.00mm	2.54mm	10
F100T254P16	1.00mm	2.54mm	16
F100T254P20	1.00mm	2.54mm	20
F127T127P04	1.27mm	1.27mm	4
F127T127P05	1.27mm	1.27mm	5
F127T127P06	1.27mm	1.27mm	6
F127T127P08	1.27mm	1.27mm	8
F127T127P10	1.27mm	1.27mm	10
F127T127P16	1.27mm	1.27mm	16
F127T127P20	1.27mm	1.27mm	20

Part Number	From Pitch	To Pitch	Pin Count
F127T200P04	1.27mm	2.00mm	4
F127T200P05	1.27mm	2.00mm	5
F127T200P06	1.27mm	2.00mm	6
F127T200P08	1.27mm	2.00mm	8
F127T200P10	1.27mm	2.00mm	10
F127T200P16	1.27mm	2.00mm	16
F127T200P20	1.27mm	2.00mm	20
F127T254P04	1.27mm	2.54mm	4
F127T254P05	1.27mm	2.54mm	5
F127T254P06	1.27mm	2.54mm	6
F127T254P08	1.27mm	2.54mm	8
F127T254P10	1.27mm	2.54mm	10
F127T254P16	1.27mm	2.54mm	16
F127T254P20	1.27mm	2.54mm	20
F200T200P04	2.00mm	2.00mm	4
F200T200P05	2.00mm	2.00mm	5
F200T200P06	2.00mm	2.00mm	6
F200T200P08	2.00mm	2.00mm	8
F200T200P10	2.00mm	2.00mm	10
F200T200P16	2.00mm	2.00mm	16
F200T200P20	2.00mm	2.00mm	20
F200T254P04	2.00mm	2.54mm	4
F200T254P05	2.00mm	2.54mm	5
F200T254P06	2.00mm	2.54mm	6
F200T254P08	2.00mm	2.54mm	8
F200T254P10	2.00mm	2.54mm	10
F200T254P16	2.00mm	2.54mm	16
F200T254P20	2.00mm	2.54mm	20
F254T254P04	2.54mm	2.54mm	4
F254T254P05	2.54mm	2.54mm	5
F254T254P06	2.54mm	2.54mm	6
F254T254P08	2.54mm	2.54mm	8
F254T254P10	2.54mm	2.54mm	10
F254T254P16	2.54mm	2.54mm	16
F254T254P20	2.54mm	2.54mm	20