

30cc syringe (with piston, front cover, rear cover, two tips, plunger) – Qty1

Product Highlights

OEM CHIPQUIK 30cc syringe (with plunger)
 Quantity 1
 Compatible with CHIPQUIK Syringe Gun SMDSG30CCR

Specifications

Optical Density (OD): 0.036
 Light Transmittance (% Transmittance): 94.786
 (Light Source Test Wavelength: 380nm to 760nm)

Includes:

syringe x1
 piston x1
 front cover x1
 rear cover x1
 conical plastic dispensing tip (18 gauge) x1
 straight stainless steel dispensing tip (18 gauge) x1
 plunger x1
 plunger retainer x1



Packaging:

All parts come unassembled.

Compatible with CHIPQUIK manual syringe gun:
 SMDSG30CCR

Compatible with all CHIPQUIK dispensing tips:

Part Number	Tip Type	Tip Gauge	Tip Orifice Internal Diameter (mm)	Tip Orifice Internal Diameter (inches)
SMDTA30	Straight Stainless Steel / Conical Plastic	Multiple (15 sizes)	Multiple (15 sizes)	Multiple (15 sizes)
SMDTA200	Straight Stainless Steel	Multiple (8 sizes)	Multiple (8 sizes)	Multiple (8 sizes)
SMDN-16G	Straight Stainless Steel	16	1.194 mm	0.0470 inches
SMDN-18G	Straight Stainless Steel	18	0.838 mm	0.0330 inches
SMDN-19G	Straight Stainless Steel	19	0.686 mm	0.0270 inches
SMDN-20G	Straight Stainless Steel	20	0.603 mm	0.0237 inches
SMDN-21G	Straight Stainless Steel	21	0.514 mm	0.0202 inches
SMDN-22G	Straight Stainless Steel	22	0.413 mm	0.0163 inches
SMDN-23G	Straight Stainless Steel	23	0.337 mm	0.0133 inches
SMDN-25G	Straight Stainless Steel	25	0.305 mm	0.0120 inches
SMDN-26G	Straight Stainless Steel	26	0.260 mm	0.0102 inches
SMDN-27G	Straight Stainless Steel	27	0.210 mm	0.0083 inches
SMDC-14G	Conical Plastic	14	1.600 mm	0.0630 inches
SMDC-16G	Conical Plastic	16	1.194 mm	0.0470 inches
SMDC-18G	Conical Plastic	18	0.838 mm	0.0330 inches
SMDC-20G	Conical Plastic	20	0.603 mm	0.0237 inches
SMDC-22G	Conical Plastic	22	0.413 mm	0.0163 inches
SMDC-25G	Conical Plastic	25	0.260 mm	0.0102 inches

Notes

Dispensing tip colors may differ from image

Syringe Dimensions

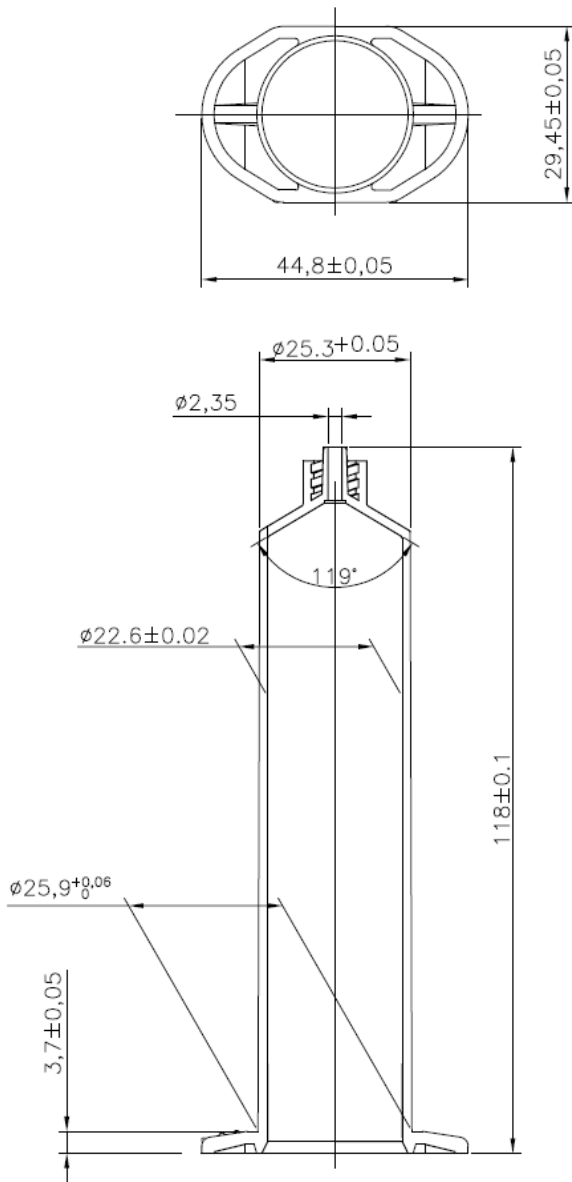

Image 1: 30cc syringe dimensions (in mm)